

Panasonic

WIFAN



Leading Innovation
in Comfort





Mobile Application Control

App-enabled* ceiling fan that connects to your Wi-Fi network and allows user to control their fans using mobile devices.

*Requires Android 6 and above or iOS 12 and above for the app to work.

Wi-Fi Ceiling Fan Connection

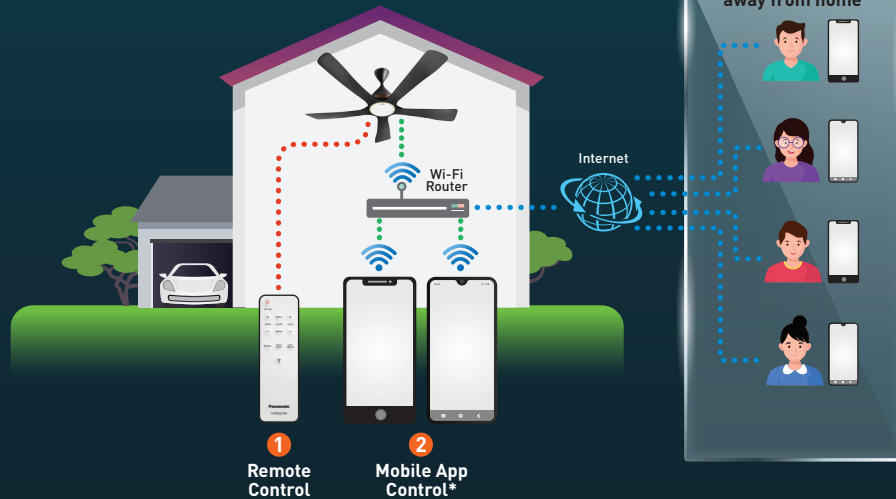

*One user account can only control up to 8 WIFAN ceiling fans

*One WIFAN ceiling fan can only be registered by 4 user accounts

Advantages of Mobile App Control

Comfort

Remotely turns on the ceiling fan using the Mobile App before arriving home to enjoy the comfortable air.

Convenient

Control and manage your ceiling fans from anywhere and anytime using your mobile devices.

Customization

Preset your ceiling fan's fan and light setting according to your preferences to suit your daily activities.

Energy Efficient

Eliminate the wastage of energy consumption from the unattended ceiling fans which are left behind by enable to turn them off even when you're away from home.

Hassle Free

Control your ceiling fan using your mobile devices without having to search for the remote control.

Security

Operate the ceiling fan at preset schedule (day and time) when away from home or on long vacation as a method for crime prevention.

Timely

Make use of the "Scheduling Function", "Sleep Mode" and On/Off Timer to suits your daily activities

Time Saving

Controls multiple ceiling fans simultaneously.



Features Available in the App



LED Lighting (Applicable for M15GCVBKSH & F-M12GCVBKH)

LED ceiling fan provides you greater space with the lighting incorporated into the fan. LED is used due to its long lifespan and also simply because it is energy saving.

Brightness

Brightness = Up to 200 lx*

Power Consumption

Up to 19W*

19W LED light = Incandescent lamp 4 x 60W

Coverage*

< HIGH > - 200lx

- i) 4m coverage - strong lighting
- ii) 6m coverage - moderate lighting
- iii) 8m coverage - weak lighting

85% Energy Saving*

* LED Light compared to incandescent bulb.

Hassle-free - No Bulb Replacement Needed

With the long lifespan of LED light, there is no need to constantly change your light bulb - and reduce garbage waste.

Adjustable Color Temperature

Normal Light Mode



Night Light Mode



Mode	Normal Light Mode	Night Light Mode
Adjustable Brightness Level	Min: 25(lx) Max: 200(lx)	Min: 0.15(lx) Med: 0.60(lx) Max: 1.10(lx)

Preset Lighting Scene Setting (Applicable for F-M15GCVBKSH & F-M12GCVBKH)

Preset with 4 light setting for 4 common daily activities.

The preset scene can also be overwritten by adjusting the light setting according to your preferred comfort level and save the setting for easy 1-Touch access.

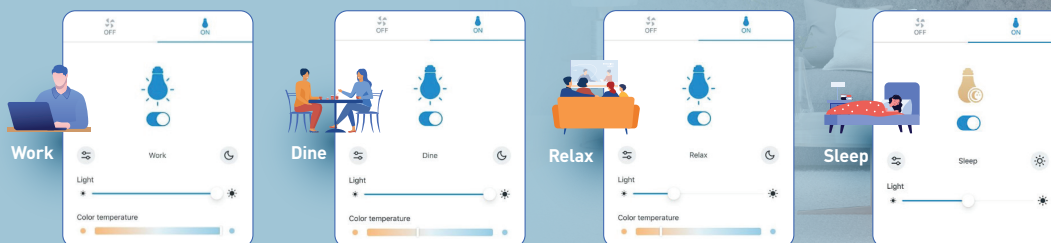

1/f Yuragi (Natural Breeze Function)

Comfortable - 1/f Yuragi (Natural Breeze)

These fans are equipped with 1/f Yuragi function which is a fluctuating pattern to generate a gentle breeze. By this sophisticated formula, in varying air velocity and controlling wind force, these new ceiling fans give you a peaceful and comfortable feeling.

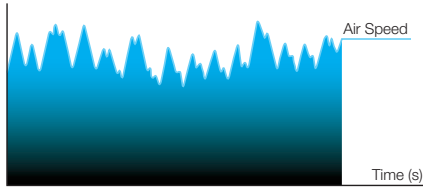

Speed notch toggles based on Yuragi pattern

Incorporated with this human-concerned technology, this kind of rhythm maintains your external body temperature by giving you a feeling of natural wind when there is a change of wind velocity.

Comment after 20 minutes usage

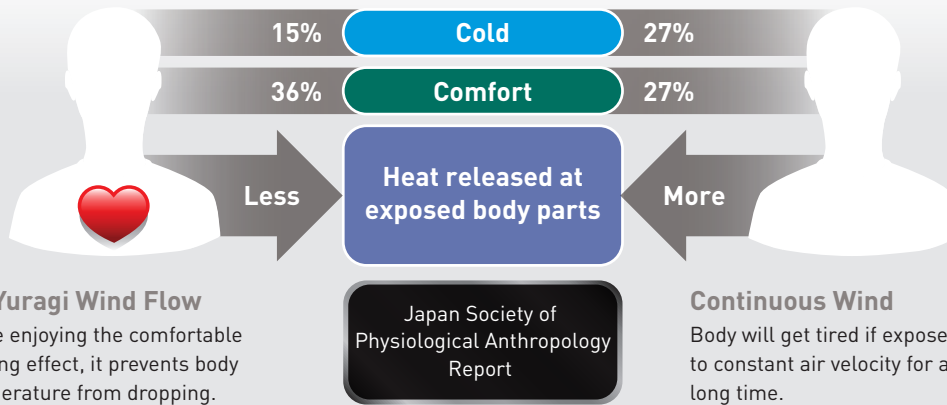

Reverse Function

The reverse function rotates the ceiling fan in a clockwise mode and draws cool air upwards and circulates the air around the room for an even air flow and comfortable temperature. The reverse function complements with the functions of an air conditioner and helps to maximize the effectiveness of the air conditioner.



Reverse function rotates clockwise



without Reverse function



with Reverse function

New Generation DC Motor

More Compact DC Motor Unit

Built-in PCB to create a mono form outlook

Higher Motor Power Output

For higher air volume and wider air flow

DC Motor ENERGY SAVING

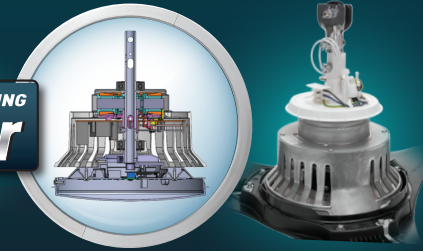

How DC Motor works?

AC motor VS DC motor

AC (Alternative Current) motor connects directly to a power source where it creates the moment of force required to rotate the motor's rotor.

As for DC (Direct Current) motor, the direct (AC) power source will be connected to a transformer which converts the power to DC. The effect will decrease the amount of power used by a direct current instead of the alternating current. The motor's rotor will then be rotated by using a system of magnets of opposing polarity where this process requires less electrical energy.



AC motor



DC motor

DC Motor is more compact & half the size of AC motor

Advantages of a DC motor:

1. Uses less energy – compared AC motor
2. Quiet operation
3. More compact and lighter motor

New Printed Circuit Board (PCB)

Compact Size Circuit

A 3-in-1 and smaller size components driven by high voltage.

Constant Wattage Control

Maintain constant wattage control. Stable delivery of large air volume & wide airflow even when there is fluctuation in voltage.

Memory Function

Memorizes last setting even when wall switch is switched off. Fan and light will operate at previous fan speed or light setting when the ceiling fan is turned on the next time.

Intelligent Motor Drive System (IMDS)

Motor Faulty Detection – Able to detect motor abnormality such as motor stop or running slow and stops the fan from rotating to prevent unsafe condition.

Blade Faulty Detection* – An additional protection against blade drop. It will stop the fan from rotating to prevent unsafe condition if an abnormal fan rotation is detected.

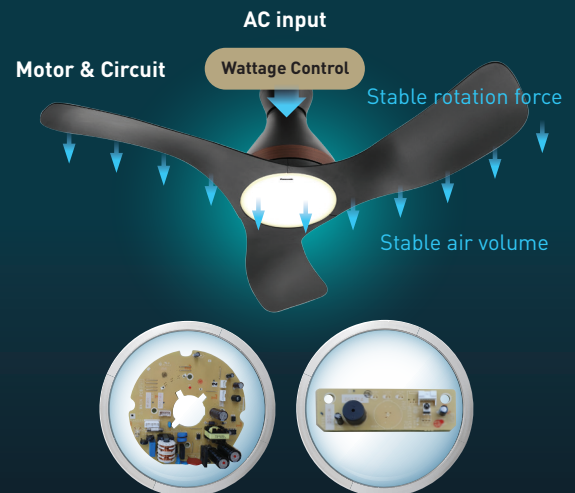

This system is a detection mechanism that will turn off the fan if it detects any abnormality.

**Applicable only for F-M15GCVBKSH and F-M15ECVBKSH*

Innovative Blade Design



60"blade

Applicable for
F-M15GCVBKSH
F-M15ECVBKSH

Wider Air Delivery

Blade shapes like an eagle's wings for wider and stronger air flow.



Normal Blade

Pressure contour

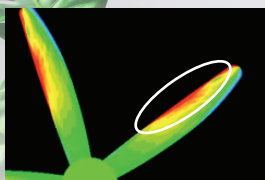

Torque towards center of blade

Vector Diagram

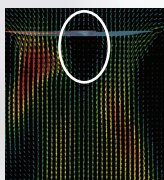

Sway towards the center due to influence of vortex and caused the wind not spreading effectively

New Blade

Pressure contour

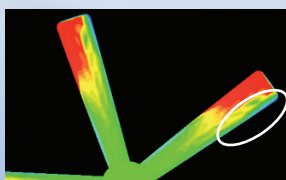

Torque at the edge of blade for wider wind spread

Vector Diagram

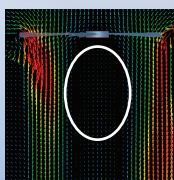

Blade designed to suppress central vortex allowing wind to spread easily

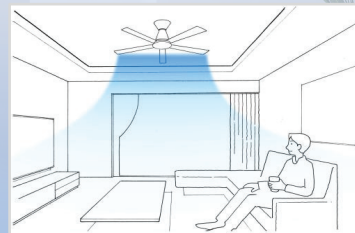

Wider air delivery without having any additional air moving products to enjoy comfortable wind

48"blade

Applicable for
F-M12GCVBKH
F-M12ECVBKH

More Silent And Low Noise

Blade shapes like an owl's wings for soft and silent air flow.



Normal Blade

Straight Blade

Cuts air at the same timing

Blade angle & width are narrow and at the same angle

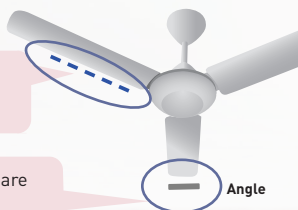

New Blade

3D Curve blade

Blade tip moves in advance to the rotational direction and does not cut air at same timing

Blade turn gradually causing small pressure change to create smooth and quiet air

Rotational direction

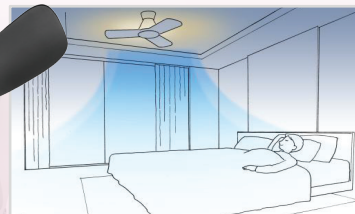
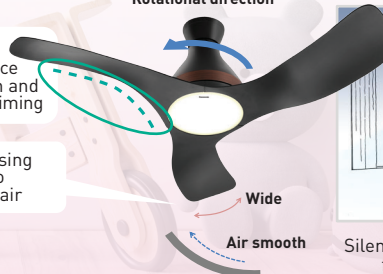

Silent air flow with less noise disturbance for a relaxing and peaceful sleep

Simple and Contemporary Remote Control

- 1 **Off/On Button:** Press to activate or stop ceiling fan
- 2 **“+” Speed Button:** Increases the fan speed
- 3 **“-” Speed Button:** Decreases the fan speed
- 4 **Reverse Button:** Changes the direction of fan rotation (clockwise, anticlockwise)
- 5 **Wi-Fi Button:** Press to activate or turn off the ceiling fan wireless network
- 6 **Night Light Button:** Press to select LED NIGHT LIGHT mode
- 7 **Warm Mode Button:** Press to adjust WARM colored LED Light
- 8 **White Mode Button:** Press to adjust WHITE colored LED Light
- 9 **“+” Light Button:** Increases the light brightness gradually
- 10 **“-” Light Button:** Decreases light brightness gradually
- 11 **Light Off/On Button:** Turns Off or turns On the Light



Remote control for
F-M15GCVBKSH &
F-M12GCVBKH

Remote control for
F-M15ECVBKSH &
F-M12ECVBKH

Safety Features

To pursue a higher quality of life, ceiling fans are expected to have more functions and value added features. However, it is also crucial to consider the safety and reliability features of the fan when you select a ceiling fan.

Safety Policy by Panasonic

Preventive Measures for Safety

Panasonic aims to minimize and reduce accidents to occur. Thus, Panasonic practices safety policy to prevent any dangerous mishaps.

1 Prevention of body falling off

- Safety Wire
- Cut-off Safety Switch

2 Prevention of blade falling off

- Blade Safety Plate

3 Prevent motor from overheating

- Safety with IMDS

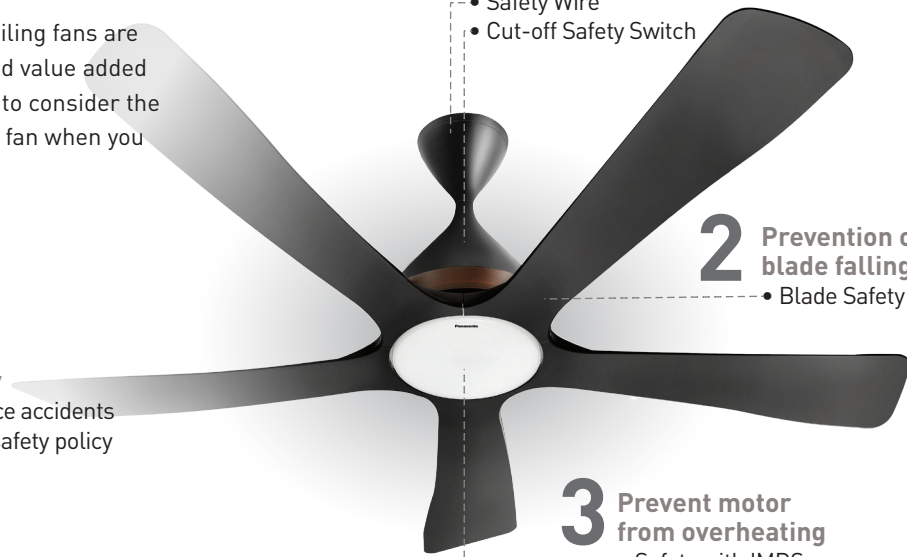

Cut-off Safety Switch

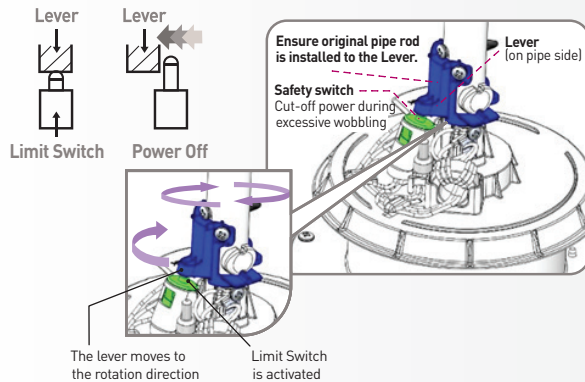

Problem

If there is any damage at either the shaft or the bolt due to improper installation, abnormal wobbling from fan will occur when it operates. The damage will cause the shaft or the bolt to break if the fan continues to operate.

Preventive Measures

When there is excessive wobbling, the safety cut-off switch will be triggered and power supply will be cut off. The cut-off switch works by detaching the lever from the switch and the fan will stop.

If Motor stops

Stop using immediately and seek contact for qualified installers or authorized Panasonic service dealers for assistance.

Blade Safety Plate

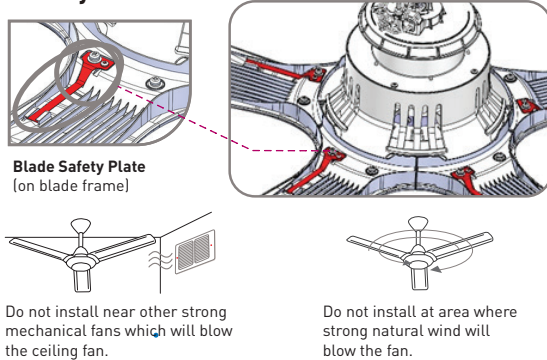

Problem

The fan blade may detach from the fan motor should there be improper installation coupled with the fan blade wearing off, deformed blade shape or stronger wind blowing to the fan.

Preventive Measures

The broken blade will be visibly hanging with the aid of safety blade hook when the fan is functioning (as shown in the picture) as an indication.

If Blade breaks

Stop using immediately and seek contact for qualified installers or authorized Panasonic service dealers for assistance.

Safety Wire

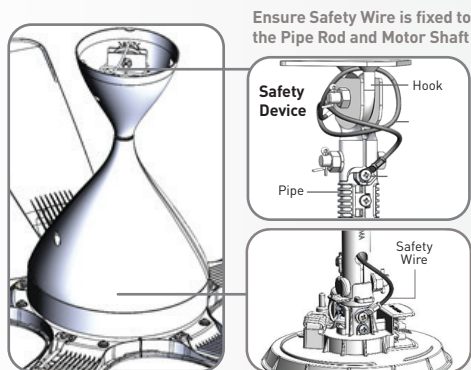

Problem

Due to improper installation or should malfunction occur, the fan motor may detached from the pipe rod due to factors such as wearing of shaft bolt, etc.

Preventive Measures

The safety wire helps to secure the fan motor with the ceiling hook to prevent the motor from falling when the fan motor detaches from the pipe rod.

If need shorter/longer pipe

Contact qualified installers or authorized Panasonic service dealers for assistance.

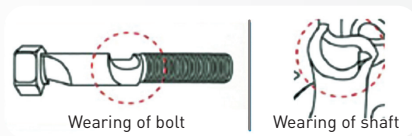

Use the original pipe rod

Original pipe rod comes with the safety wire and safety cut-off switch in line with Panasonic safety policy. Also, do ensure the pipe rod is fully tightened to the motor shaft. [Bolt tightening torque is 800 – 1200 N.com]

WIFAN

F-M15GCVBKSH



DC Motor ENERGY SAVING

LED

WiFi CERTIFIED

Available on the App Store

GET IT ON Google Play

Installation Space (unit:mm)

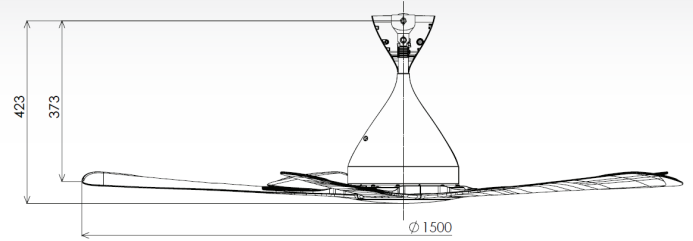

Features

- 5-Blade Design
- Wider Air Delivery
- LED Lighting - Adjustable Colour Temperature & Brightness
 - Adjustable Brightness for Night Light Mode
 - Preset 4-Scene Setting*
- Mobile App Control
- Simple and Contemporary Remote Control
- New Generation DC Motor
- Yuragi (Natural Breeze Function)
- Reverse Function
- Scheduling Function*
- Grouping Function*
- Sleep Mode*
- ON/OFF Timer*
- Enhanced Safety Features
- Durable ABS-GF Blades

Dimension

Width: Ø1500mm (60")
Height: 423mm

Colour

Black

*Only available in the Mobile App

WIFAN

F-M15ECVBKSH



DC Motor ENERGY SAVING

WiFi CERTIFIED

Available on the App Store

GET IT ON Google Play

Installation Space (unit:mm)

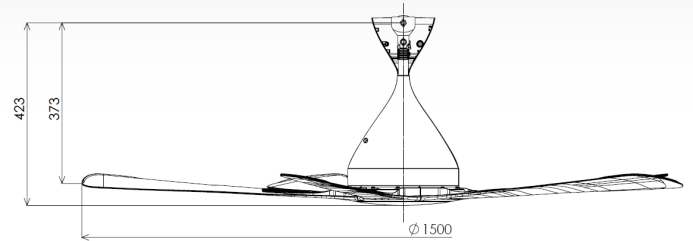

Features

- 5-Blade Design
- Wider Air Delivery
- Mobile App Control
- Simple and Contemporary Remote Control
- New Generation DC Motor
- Yuragi (Natural Breeze Function)
- Reverse Function
- Scheduling Function*
- Grouping Function*
- Sleep Mode*
- ON/OFF Timer*
- Enhanced Safety Features
- Durable ABS-GF Blades

Dimension

Width: Ø1500mm (60")
Height: 423mm

Colour

Black

*Only available in the Mobile App

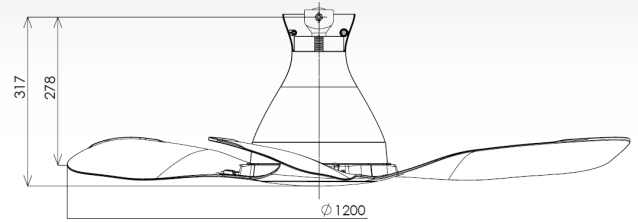
WIFAN**F-M12GCVBKH****DC Motor****LED****WiFi CERTIFIED**Available on the **App Store**GET IT ON **Google Play****Installation Space (unit:mm)****Features**

- 3-Blade Design
- Gentle & Silent Air Flow
- LED Lighting - Adjustable Colour Temperature & Brightness
 - Adjustable Brightness for Night Light Mode
 - Preset 4-Scene Setting*
- Mobile App Control
- Simple and Contemporary Remote Control
- New Generation DC Motor
- Yuragi (Natural Breeze Function)
- Reverse Function
- Scheduling Function*
- Grouping Function*
- Sleep Mode*
- ON/OFF Timer*
- Enhanced Safety Features
- Durable ABS-GF Blades

Dimension

Width: Ø1200mm (48")
Height: 317mm

Colour

Black

*Only available in the Mobile App

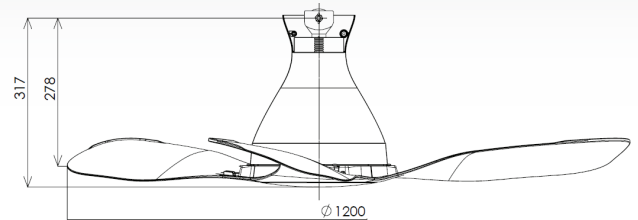
WIFAN**F-M12ECVBKH****DC Motor****WiFi CERTIFIED**Available on the **App Store**GET IT ON **Google Play****Installation Space (unit:mm)****Features**

- 3-Blade Design
- Gentle & Silent Air Flow
- Mobile App Control
- Simple and Contemporary Remote Control
- New Generation DC Motor
- Yuragi (Natural Breeze Function)
- Reverse Function
- Scheduling Function*
- Grouping Function*
- Sleep Mode*
- ON/OFF Timer*
- Enhanced Safety Features
- Durable ABS-GF Blades





Dimension

Width: Ø1200mm (48")
Height: 317mm

Colour

Black

*Only available in the Mobile App

Model								
	F-M15GCVBKSH		F-M15ECVBKSH		F-M12GCVBKSH		F-M12ECVBKSH	
Features								
Motor Type	DC Motor (New Generation)							
LED Lighting	●				●			
1/f Yuragi	●		●		●		●	
Remote Control	●		●		●		●	
Mobile App Control	●		●		●		●	
Reverse Function	●		●		●		●	
Blade Type	ABS-GF (Glass Fiber)							
Colour	Black							
Specifications								
Dimension	Width			Ø1500 mm (60")	Ø1500 mm (60")	Ø1200 mm (48")	Ø1200 mm (48")	
	Height			423 mm	423 mm	317 mm	317 mm	
Power Consumption	Fan Only	Low	W	4	4	3	3	
		High	W	54	54	31	31	
Forward Fan Speed	Low		RPM	80	80	55	55	
	High		RPM	245	245	170	170	
Reverse Fan Speed	Low		RPM	80	80	55	55	
	High		RPM	255	255	170	170	
Air Velocity			(m/min)	160	160	185	185	
Air Delivery			(m ³ /min)	300	300	200	200	
Noise Level (dB)				59	59	41	41	
Wi-Fi Frequency Range					2.4 GHz			
Mobile App OS					iOS / Android			



Please scan QR code or visit WIFAN microsite for more details :
fan.my.panasonic.com/wifi

- All information contained in this leaflet is correct at the time of printing, and is subject to change without prior notice.
- Images are for illustration purpose only.
- Due to printing considerations, the actual color may vary slightly from those shown.
- Panasonic Malaysia Sdn. Bhd. reserves the right to revise any content in this catalogue as it deems fit without prior notice.